

DEORE XT Freehub (8/9-Speed)
FH-M770-S Silver Version

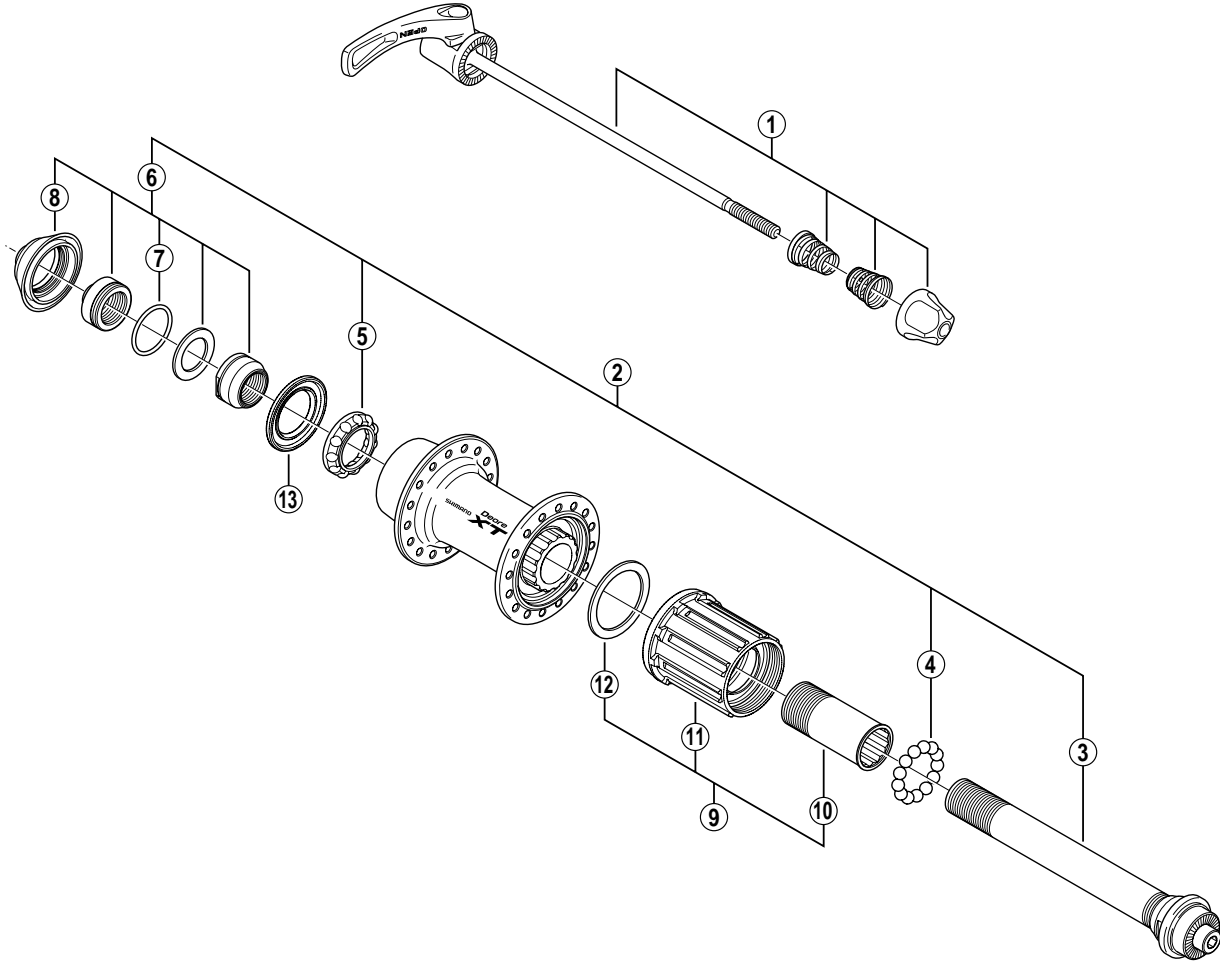

• Over Lock Nut Dimension: 135 mm (5-5/16")

ITEM NO.	SHIMANO CODE NO.	DESCRIPTION	INTERCHANGEABILITY		
			FH-M775	FH-M970	FH-M760
1	Y-3D0 98010	Complete Quick Release 168 mm (6-5/8")	A	B	B
	Y-3D0 98030	Complete Quick Release 173 mm (6-13/16")	A	B	B
2	Y-3CZ 98010	Complete Hub Axle			
3	Y-3CZ 98020	Hub Axle Unit	A	B	
4	Y-000 91210	Steel Ball (3/16") 20 pcs.	A	B	
5	Y-26J 98030	Ball Retainer (3/16")	A		
6	Y-3CZ 98030	Left Hand Lock Nut Unit			
7	Y-26J 12000	O-Ring	A		
8	Y-26J 11000	Dust Cap	A		
9	Y-3CZ 98040	Complete Freewheel Body w/Body Fixing Bolt	A	B	
10	Y-3CZ 18000	Body Fixing Bolt	A	B	
11	Y-3CZ 98050	Freewheel Body Unit	A	B	
12	Y-3CZ 12000	Freewheel Body Washer	A	B	
13	Y-26D 10000	Seal Ring	A	A	

A: Same parts.

B: Parts are usable, but differ in materials, appearance, finish, size, etc.

Absence of mark indicates non-interchangeability.

0801-2699A

Specifications are subject to change without notice.

SHIMANO